

## PRODUCT SPEC SHEET/KEY SPECIFICATIONS

### UNDER EAVE/SOFFIT VENTS Model # UE2051-PG

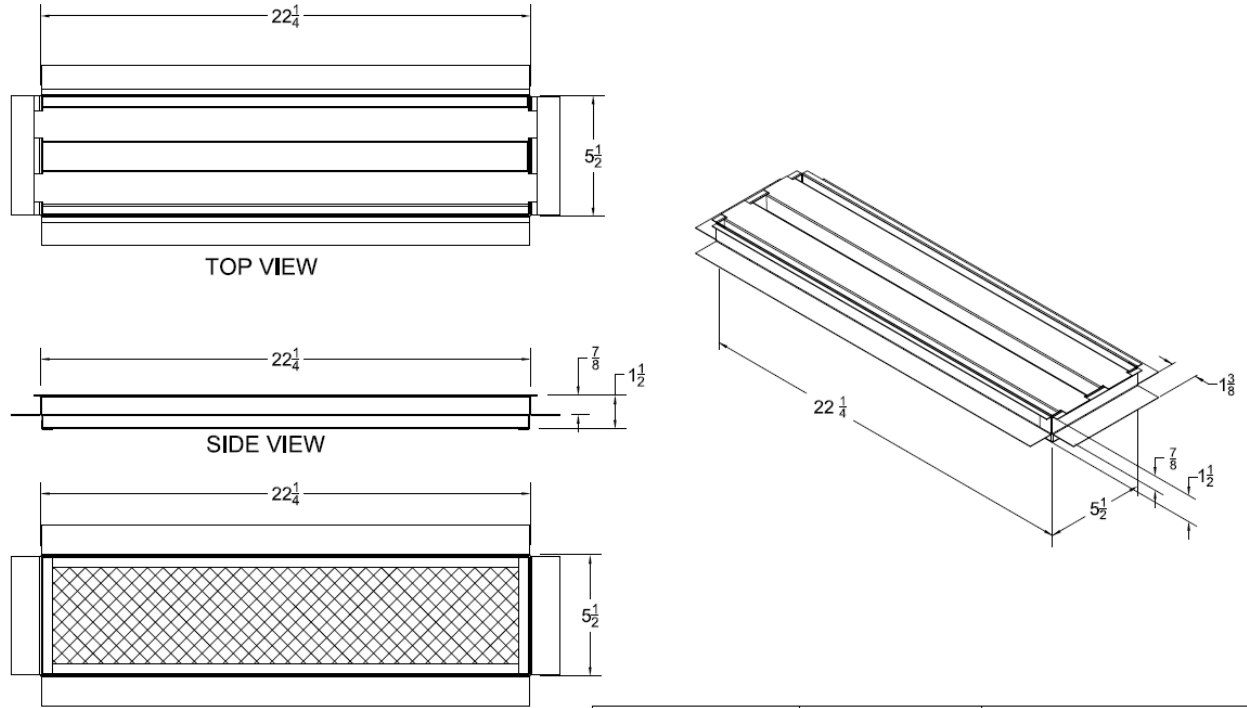

Under Eave/Soffit Vents	Model	Size L x W	NFVA Provided	Flanges available	Flange Definition	Weight
	UE2051-PG	22 " x 5.5"	36.5	Plaster Ground	7/8" Setback	7lbs
Continuous Vents and other CUSTOM SIZES AVAILABLE						

### BENEFITS:

- Safety vents that are used in areas prone to wildfires, wind driven rain, or wind driven snow.
- Overlapping Baffle Protection ( Patent Pending )
  - Air Flows through normally
  - Resists the intrusion of Flame and Embers, Wind Driven Rain and Wind Driven Snow
- Compliant with new California Ch7a Building Code
- 20 Year Warranty
- Easy Install

### STANDARD MATERIALS

3/4" Mesh standard unless otherwise requested

Astm A653/A653M- G90 hot dipped galvanized steel, 26GA

ASTM D9092- mill phosphatized coating for painting. IF BONDERIZED

ASTM b370- Sheet Copper, 16oz and 20oz, IF COPPER

**Installation:** Install like any other similar Ventilator Product on the market.