

3.5" x 14" EXTREME Soffit/Eave Vent Model # UE3021

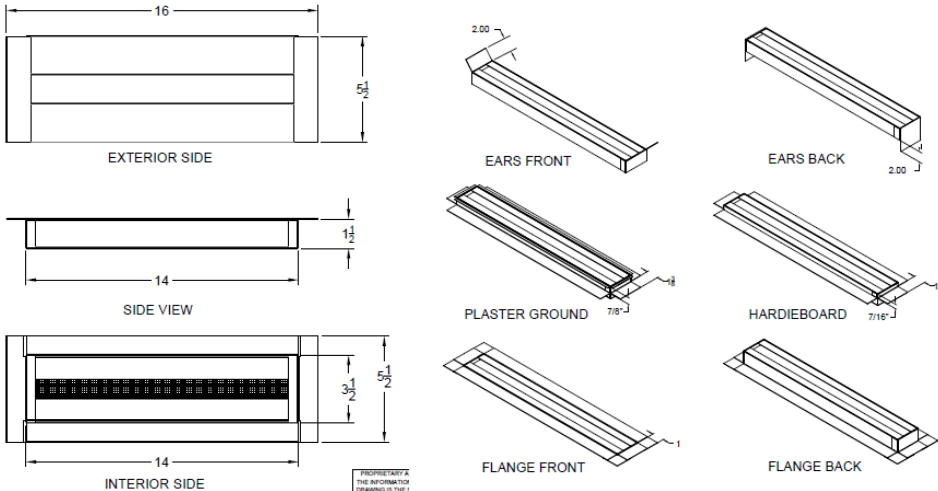

| Soffit/Eave Vents | Model | Size W x L | NFVA Provided (sq in) | Flanges Available | Flange Definition | Weight |
|--|-----------|------------|-----------------------|-------------------|-------------------|--------|
| | UE3021-FF | 3.5" x 14" | 13 | Flange Front | Flange Front | 3lbs |
| | UE3021-PG | 3.5" x 14" | 13 | Plaster Ground | 7/8" J Channel | 3lbs |
| | UE3021-H | 3.5" x 14" | 13 | Hardie/Cement | 7/16" setback | 3lbs |
| | UE3021-EF | 3.5" x 14" | 13 | Ears Front | 2" side flanges | 3lbs |
| | UE3021-EB | 3.5" x 14" | 13 | Ears Back | 2" side flanges | 3lbs |
| | UE3021-FB | 3.5" x 14" | 13 | Flange Back | Flange Back | 3lbs |
| | UE3021-RE | 3.5" x 14" | 13 | Retrofit Eave | For rafters | 3lbs |
| | UE3021-RS | 3.5" x 14" | 13 | Retrofit Soffit | Flange Front | 3lbs |
| Continuous Soffit and Custom sizes/materials AVAILABLE | | | | | | |

BENEFITS:

- Safety vents that resist intrusion of flames, embers, EXTREME radiant heat, driving rain, snow, and rodents.
- **TRIPLE PROTECTION** (Patent Pending):
 - Anti -Clogging Overlapping Baffles
 - 1-2 Hour Fire Rated Intumescent strips inside baffles
 - 1/8" mesh on back side of vent
- Air flows through normally
- Approved and used throughout California and beyond. California BML Listing # 8165-2232:0500
- Prevents Rodent Entry
- 20 Year Warranty
- Easy to Install and Paint

STANDARD MATERIALS

1/8" mesh standard unless otherwise requested

ASTM A653/A653M- G90 hot dipped galvanized steel, 26 GA

Intumescent adhesive strips(1-2 hr fire rated) installed on internal baffles to provide extreme radiant heat protection

ASTM D9092- mill phosphatized coating for painting.- If bonderized

ASTM b370- Sheet Copper, 16oz and 20oz- if copper

Installation: Install like any other similar Ventilator Product on the market.