

5" x 14" EXTREME Soffit/Eave Vent Model # UE3031

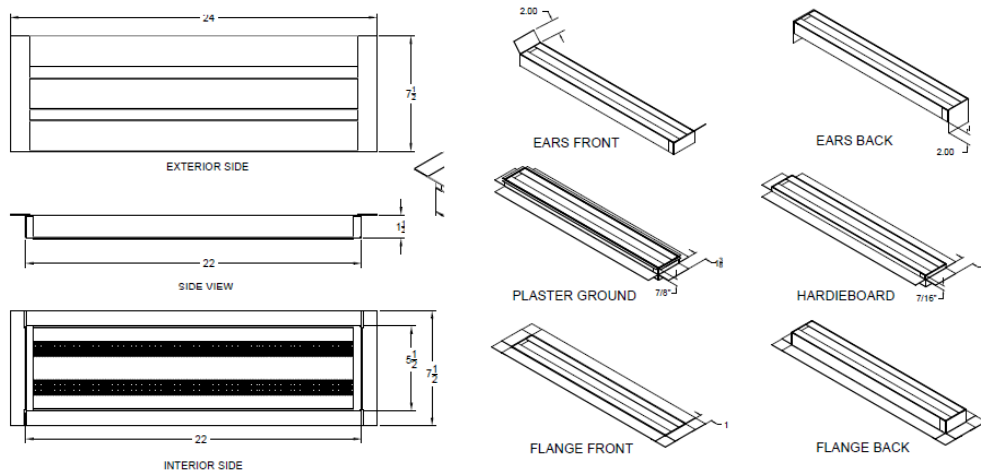

Soffit/Eave Vents	Model	Size W x L	NFVA Provided (Sq in)	Flanges Available	Flange Definition	Weight
	UE3031-FF	5" x 14"	24	Flange Front	Flange Front	3lbs
	UE3031-PG	5" x 14"	24	Plaster Ground	7/8" J Channel	3lbs
	UE3031-H	5" x 14"	24	Hardie/Cement	7/16" setback	3lbs
	UE3031-EF	5" x 14"	24	Ears Front	2" side flanges	3lbs
	UE3031-EB	5" x 14"	24	Ears Back	2" side flanges	3lbs
	UE3031-FB	5" x 14"	24	Flange Back	Flange Back	3lbs
	UE3031-RE	5" x 14"	24	Retrofit Eave	For rafters	3lbs
	UE3031-RS	5" x 14"	24	Retrofit Soffit	Flange Front	3lbs
Continuous Soffit and Custom sizes/materials AVAILABLE						

BENEFITS:

- Safety vents that resist intrusion of flames, embers, EXTREME radiant heat, driving rain, snow, and rodents.
- **TRIPLE PROTECTION** (Patent Pending):
 - Anti -Clogging Overlapping Baffles
 - 1-2 Hour Fire Rated Intumescent strips inside baffles
 - 1/8" mesh on back side of vent
- Air flows through normally
- Approved and used throughout California and beyond. California BML Listing # 8165-2232:0500
- Prevents Rodent Entry
- 20 Year Warranty
- Easy to Install and Paint

STANDARD MATERIALS

1/8" mesh standard unless otherwise requested

ASTM A653/A653M- G90 hot dipped galvanized steel, 26 GA

Intumescent adhesive strips(1-2 hr fire rated) installed on internal baffles to provide extreme radiant heat protection

ASTM D9092- mill phosphatized coating for painting.- if bonderized

ASTM b370- Sheet Copper, 16oz and 20oz- if copper

Installation: Install like any other similar Ventilator Product on the market.