

## 2" x 60" Soffit Vent Model # CS2031-FF-2X60

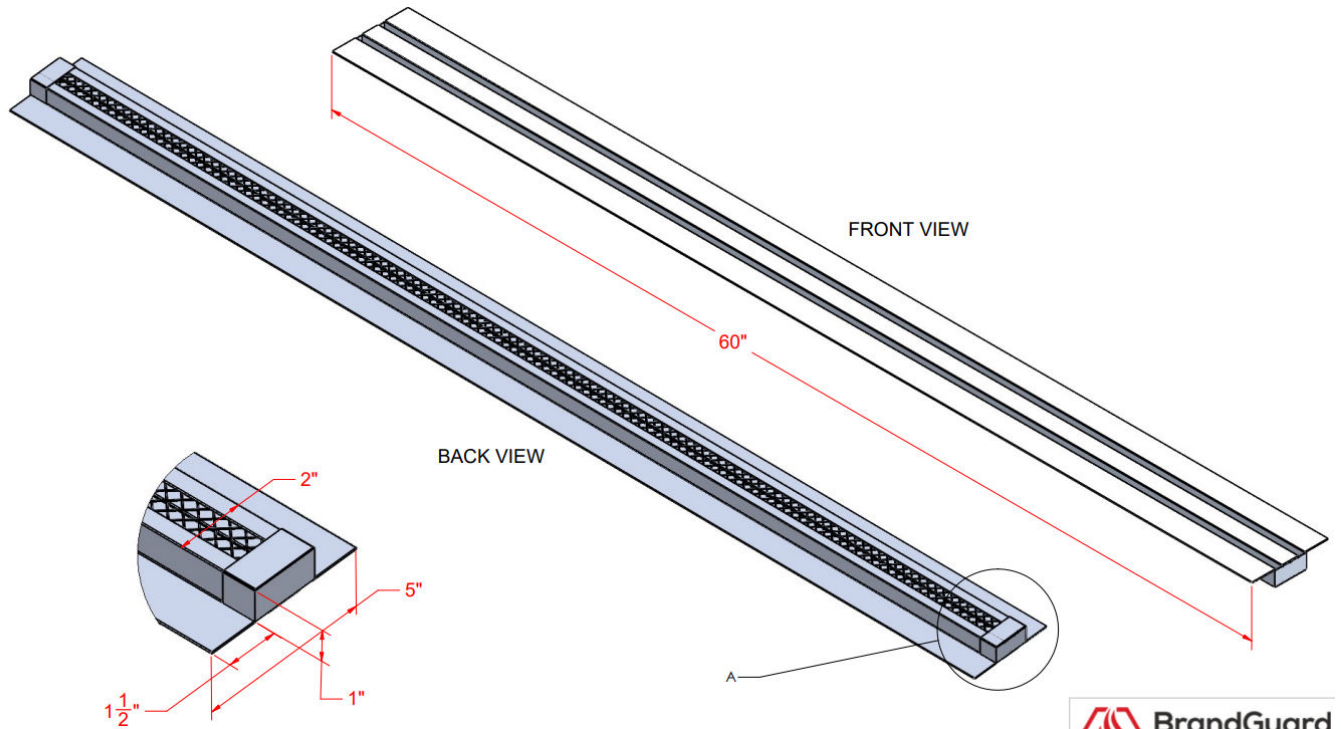

Soffit Vents	Model	Size W x L	NFVA Provided (Sq in)	Flanges Available	Flange Definition	Weight
	CS2031-FF-2X60	2" x 60"	60	Flange Front		5lbs
Custom sizes/materials AVAILABLE						

### BENEFITS:

- Safety vents that are used in areas prone to wildfires, wind driven rain, or wind driven snow.
- **Triple Protection (Patented)**
  - **Overlapping baffles** resist embers, flames and radiant heat
  - Heat activated **Intumescent Strips** expand & seal openings during extreme fire conditions
  - **1/16" mesh** on back side of vent for additional ember and bug protection
- WUI Approved for use throughout California and beyond (Calfire BML Approval # 8165-2232:0502)
- Tested and Listed to ASTM E2886/2912
- 1 hour Fire Rated per ASTM E119
- Air Flows through normally
- Also Prevents Rodent Entry
- Easy to Install, Retrofit and Paint

### STANDARD MATERIALS

ASTM A653/A653M- G90 hot dipped galvanized steel, 26GA  
 ASTM D9092- mill phosphatized coating for painting. IF BONDERIZED  
 ASTM b370- Sheet Copper, 16oz and 20oz IF GALVANIZED  
 .0625 x.0625 hot dipped galvanized 23ga wire mesh

### Installation:

Install like any other similar Ventilator Product on the market.